

500mA High PSRR, Fast Response Linear Regulator

DESCRIPTION

BL8565G series is a group of positive voltage output, low power consumption, low dropout voltage regulators.

BL8565G can provide output value in the range of 0.9V~3.6V every 0.1V step. It also can be customized on command.

BL8565G includes high accuracy voltage reference, error amplifier, current limit circuit and output driver module with discharge capability.

BL8565G has excellent load and line transient response and good temperature characteristics, which can assure the stability of chip and power system. And it uses trimming technique to guarantee output voltage accuracy within $\pm 2\%$.

BL8565G is available in SOT89-3 package which is lead-free.

FEATURES

- Low power consumption: 60uA (Typ.)
- Standby mode: 0.1uA
- Low dropout voltage:
330mV @ $I_{OUT}=500mA$, $V_{OUT}=3.3V$ (Typ.)
- High PSRR: 70dB@1KHz (Typ.)
- Low temperature coefficient: $\pm 100ppm/^{\circ}C$
- Excellent line regulation: 0.05%/V
- Output voltage range: 0.9V~3.6V
- Highly accurate: $\pm 2\%$
- Build-in chip enable and discharge circuit
- Thermal shutdown
- Overcurrent protection

APPLICATIONS

- Power source for cellular phones and various kinds of PCSs
- Battery powered equipment
- Power management of MP3, PDA, DSC, mouse, PS2 games
- Reference voltage source
- Regulation after switching power

TYPICAL APPLICATION

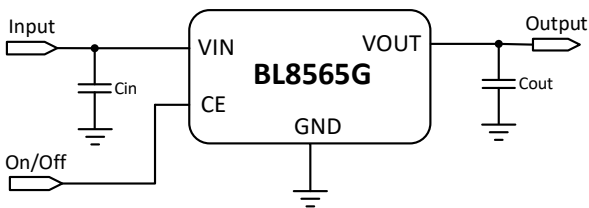

Note: Input capacitor ($C_{IN}=1\mu F$) and output capacitor ($C_{OUT}=1\mu F$) are recommended in all application circuit.

ELECTRICAL CHARACTERISTICS

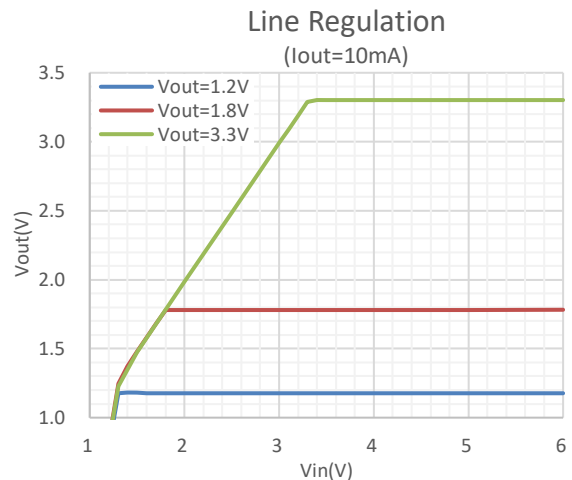

BL8565G

ORDERING INFORMATION

BL8565G [1](#) [2](#) [3](#) [4](#)

Code	Description
1	Temperature&Rohs: C: -40~85°C, Pb Free Rohs Std.
2	Package type: C3B: SOT89-3(B)
3	Packing type: TR: Tape&Reel (Standard)
4	Output voltage: e.g., 30=3.0V 33=3.3V 36=3.6V

PIN CONFIGURATION

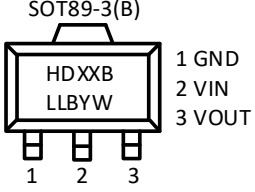
Product classification	BL8565GCC3BTR <input type="checkbox"/> <input type="checkbox"/>
HD: Product code	
XX: Output voltage	
LL: Lot No.	
B: Fab code	
YW: Date code	
GND	Ground pin
VIN	Supply voltage input
VOUT	Output voltage

Y: The Year of manufacturing, "1" stands for year 20X1, "2" stands for year 20X2, and "8" stands for year 20X8. (X=0,1,2,....,9)

W: The week of manufacturing. "A" stands for week 1, "Z" stands for week 26, "A" stands for week 27, "Z" stands for week 52.

The date code of the 53rd week is the same as that of the first week of the next year. For example, the date code of the 53rd week of 2017 is the same as that of the first week of 2018, which are 1801 and 8A.

ABSOLUTE MAXIMUM RATING

Parameter		Value
Max input voltage		8V
Operating junction temperature (T _J)		125°C
Output current		500mA
Ambient temperature (T _A)		-40°C to 85°C
Power dissipation	SOT89-3	1W
Package thermal resistance (θ _{JA})		100°C/W
Storage temperature (T _S)		-40°C to 150°C
Lead temperature & time		260°C, 10s
ESD (HBM)		>2000V

Note:

- 1) Package Thermal Resistance value can be affected by PCB design, external heat sink, ambient airflow, operating power, etc. The value shown here is for reference only.
- 2) Exceed these limits to damage to the device.
- 3) Exposure to absolute maximum rating conditions may affect device reliability.

RECOMMENDED WORK CONDITIONS

Item	Min	Recommended	Max	Units
Input voltage range	1.5 ¹		6	V
Ambient temperature	-40		85	°C

Note:

- 1) The output current capability depends on the input voltage and the minimum dropout voltage.

ELECTRICAL CHARACTERISTICS

Test condition: C_{IN}=1μF, C_{OUT}=1μF, T_A=25°C, unless otherwise specified.

Symbol	Parameter	Conditions	Min	Typ	Max	Units	
V _{IN}	Input voltage		1.5 ¹		6	V	
V _{OUT}	Output voltage	V _{OUT} >1.5V	V _{IN} =Set V _{OUT} +1V, 1mA≤I _{OUT} ≤30mA	V _{OUT} x0.98	V _{OUT}	V _{OUT} X1.02	V
		V _{OUT} ≤1.5V		V _{OUT} -0.03		V _{OUT} +0.03	
I _{OUT (Max.)}	Maximum output current	V _{IN} -V _{OUT} =1V	500			mA	
V _{DROP} ²	Dropout voltage	V _{OUT} =1.2V, I _{OUT} =500mA		938	1400	mV	
		V _{OUT} =1.8V, I _{OUT} =500mA		650	975	mV	
		V _{OUT} =3.3V, I _{OUT} =500mA		330	500	mV	
$\frac{\Delta V_{out}}{\Delta V_{in} \cdot V_{out}}$	Line regulation	I _{OUT} =10mA, Set V _{OUT} +1V≤V _{IN} ≤6V		0.05	0.2	%/V	
$\frac{\Delta V_{out}}{\Delta V_{in}}$	Load regulation	V _{IN} =Set V _{OUT} +1V, 1mA≤I _{OUT} ≤500mA		50	80	mV	
I _Q	Supply current	V _{IN} =Set V _{OUT} +1V		60		μA	
I _{STANDBY}	Supply current (Standby)	V _{IN} =Set V _{OUT} +1V, V _{CE} =GND		0.1	1.0	μA	
$\frac{\Delta V_{out}}{\Delta T \cdot V_{out}}$	Output voltage temperature coefficient	I _{OUT} =10mA		±100		ppm/°C	
PSRR	Ripple rejection	F=1KHz, Ripple=0.5Vp-p V _{IN} =Set V _{OUT} +1V		70		dB	
I _{LIM}	Current limit	V _{IN} =4.3V, V _{OUT} =3.3V	550			mA	
I _{SHORT}	Short current limit	V _{IN} =5V, V _{OUT} =0V		100		mA	
R _{PD}	CE pull down resistance			500K		Ω	
R _{DIS}	Discharge resistor	V _{CE} =GND, V _{OUT} =3.0V		1.5K		Ω	

BL8565G

T_{SD}	Thermal shutdown temp	$V_{IN}=\text{Set } V_{OUT}+1V, I_{OUT}=10mA$		160		°C
T_{SH}	Thermal shutdown hysteresis	$V_{IN}=\text{Set } V_{OUT}+1V, I_{OUT}=10mA$		30		°C
V_{CE_H}	CE input voltage "H"		1		V_{IN}	V
V_{CE_L}	CE input voltage "L"		0		0.5	V

Note:

- 1) The output current capability depends on the input voltage and the minimum dropout voltage.
- 2) $V_{DROP}=V_{IN}-V_{OUT}$ when V_{OUT} drops below 98% of the normal V_{OUT} .

BLOCK DIAGRAM

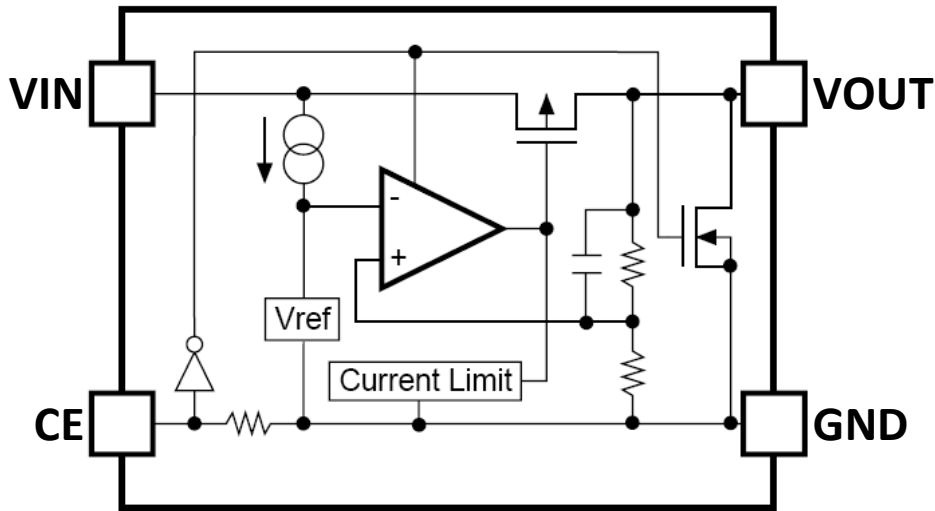

EXPLANATION

BL8565G series is a group of positive voltage output, low noise, low power consumption, low dropout voltage regulator.

BL8565G can provide output value in the range of 0.9V~3.6V every 0.1V step. It also can be customized on command.

BL8565G includes high accuracy voltage reference, error amplifier, current limit circuit and output driver module.

BL8565G has excellent load and line transient response and good temperature characteristics, which can assure the stability of chip and power system. And it uses trimming technique to guarantee output voltage accuracy within $\pm 2\%$.

TYPICAL PERFORMANCE CHARACTERISTICS

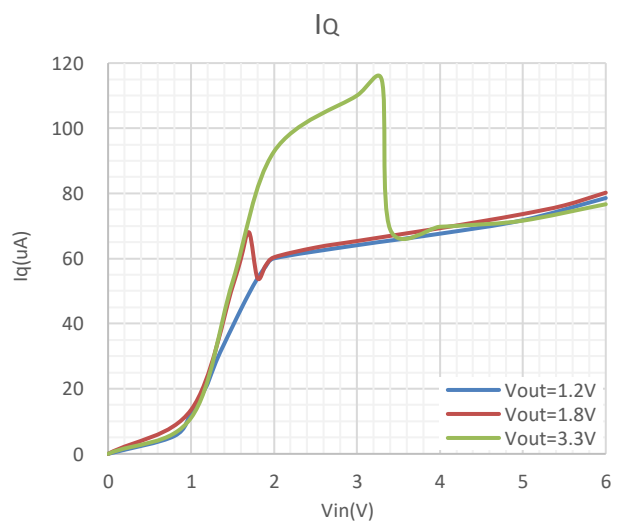
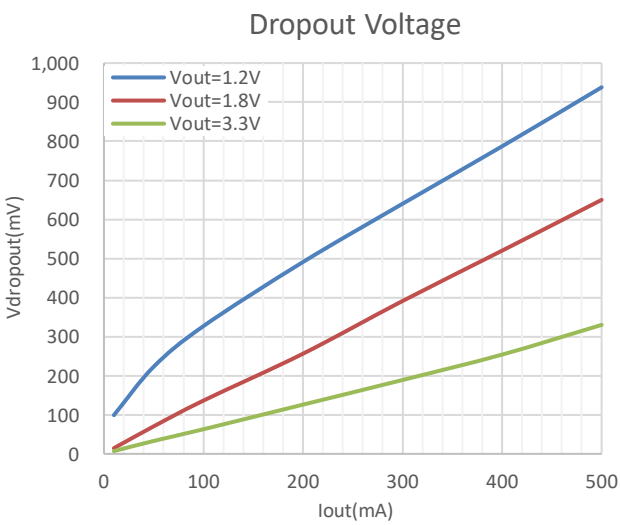
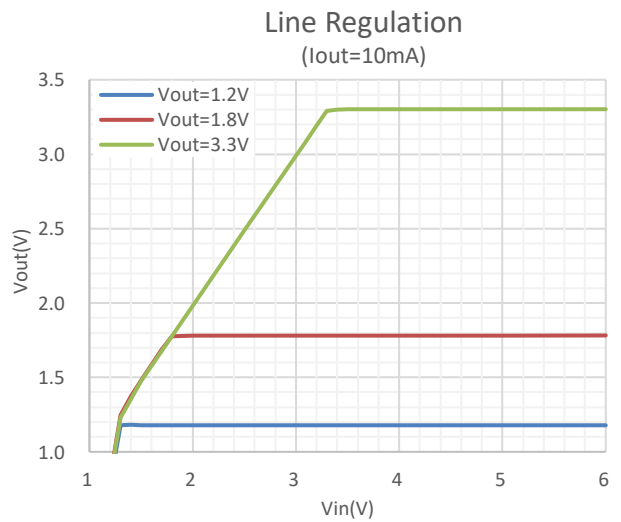
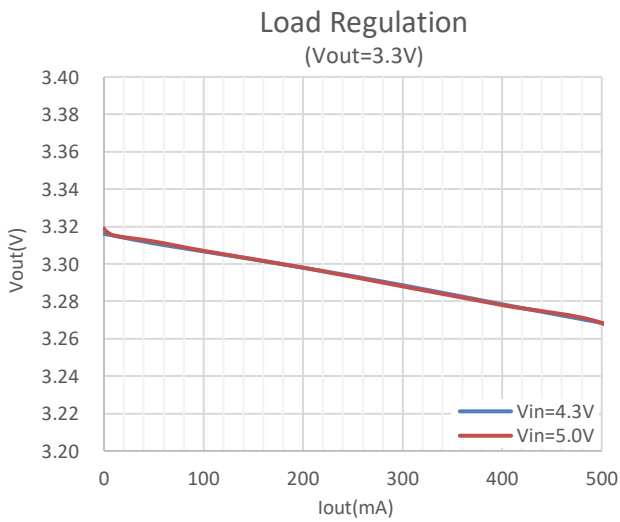
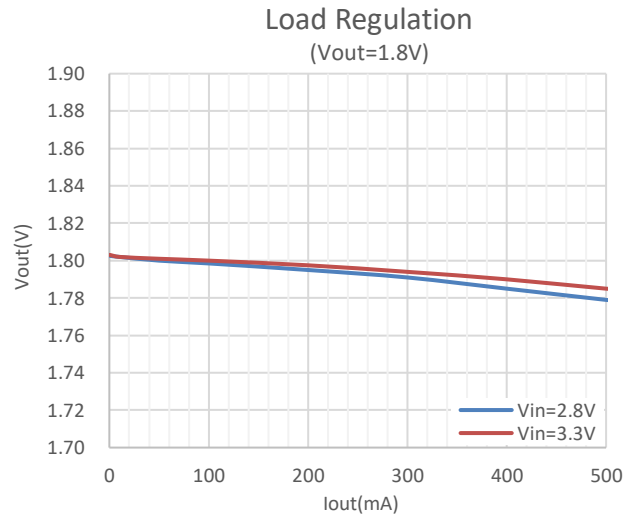
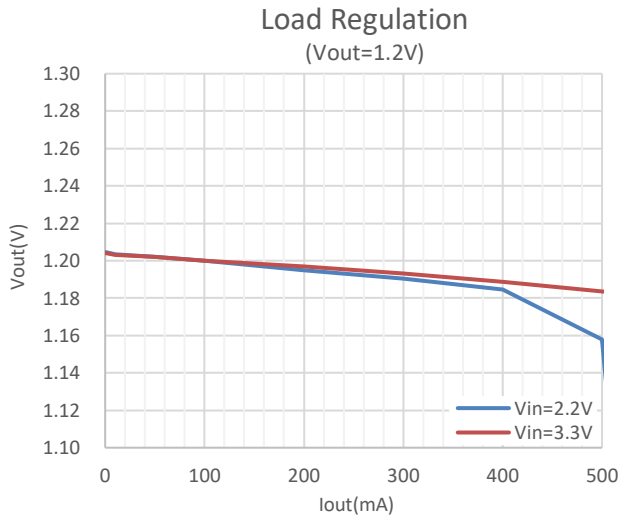

BL8565G

Current Limit

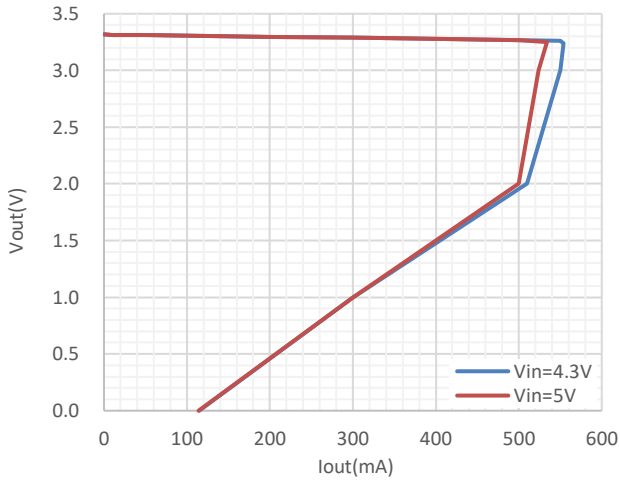

PSRR

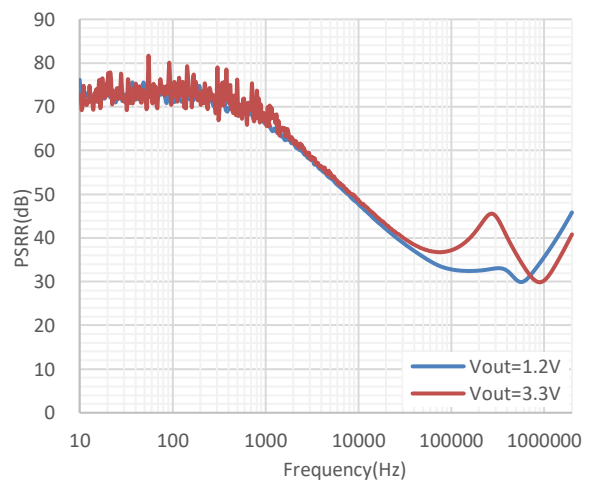

Vout vs. Temp
(Vin=5V, Iout=10mA)

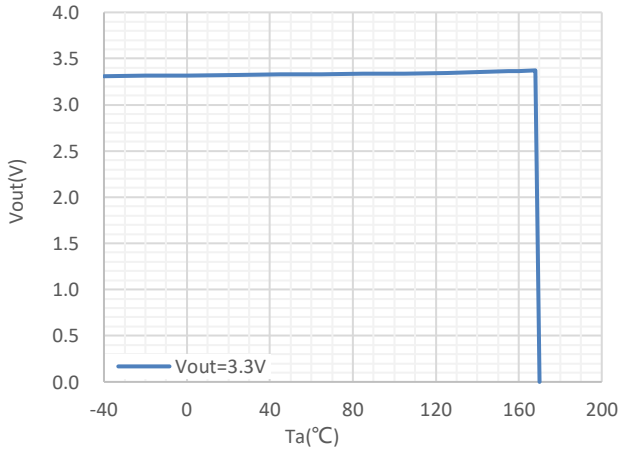

CE Threshold

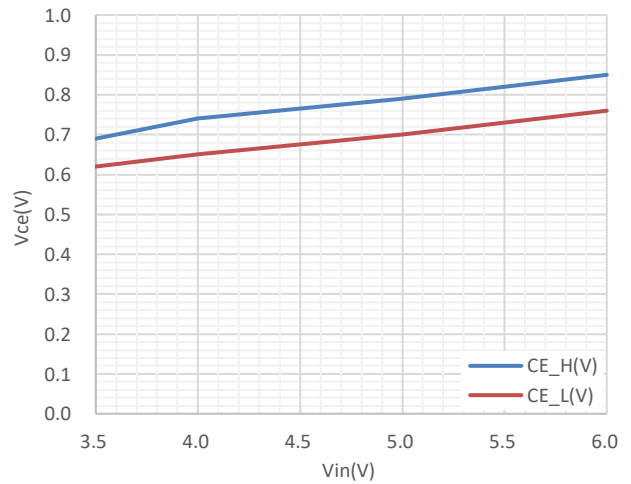

Load Transient Response

(Vin=5V, Vout=3.3V, Iout=10-500mA)

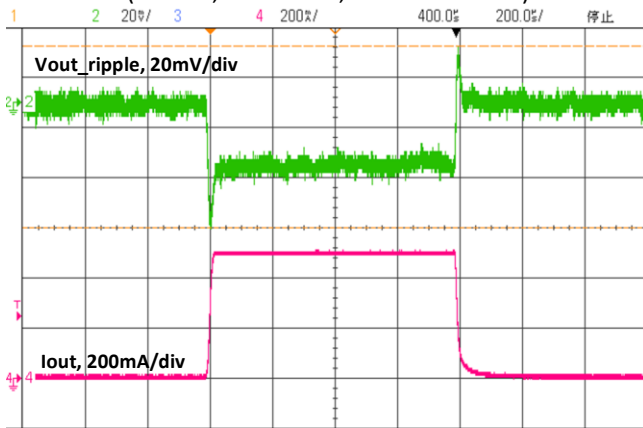

CH2: Vout_ripple, CH4: Iout

Load Transient Response

(Vin=5V, Vout=3.3V, Iout=250-500mA)

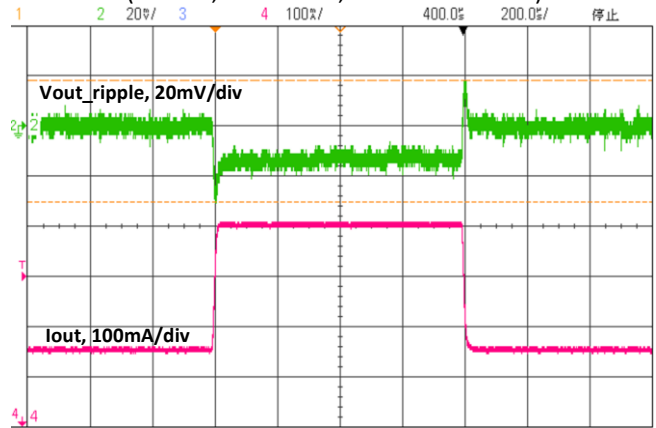

CH2: Vout_ripple, CH4: Iout

BL8565G

CE Chip Enable Response

(CE=0V to 3V, Vin=5V, Vout=3.3V, Iout=10mA)

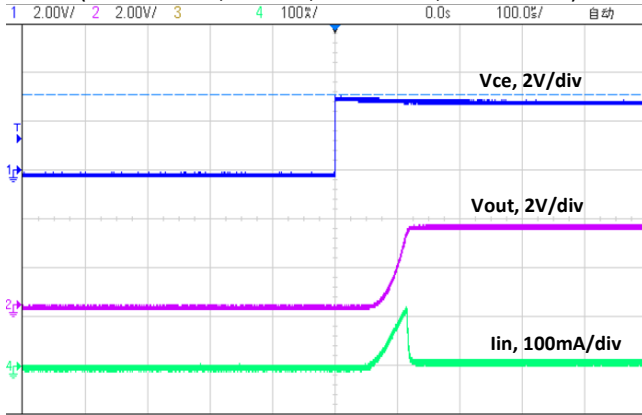

CH1: CE, CH2: Vout, CH4: Iin

CE Chip Enable Response

(CE=3V to 0V, Vin=5V, Vout=3.3V, Iout=10mA)

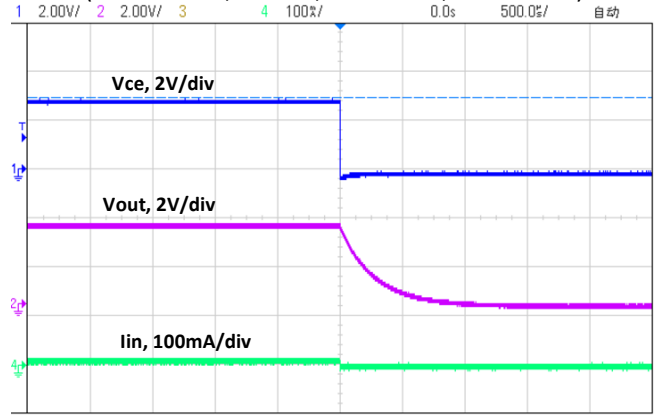

CH1: CE, CH2: Vout, CH4: Iin

PACKAGE OUTLINE

Package	SOT89-3	Devices per reel	1000pcs
Package dimension:			
<p>4.5±0.1</p> <p>1.6±0.2</p> <p>0.4</p> <p>2.5±0.1</p> <p>4.25MAX.</p> <p>0.8 MIN.</p> <p>1.5±0.1</p> <p>0.4±0.1</p> <p>0.4±0.1</p> <p>0.42±0.2</p> <p>0.47±0.1</p> <p>1.5±0.1</p> <p>1.5±0.1</p> <p>0.42±0.2</p>			
Unit: mm			